

OMAS Brand Slicer

意大利奧馬氏牌切片機

MODEL (型號): H-300 (=H-30E)

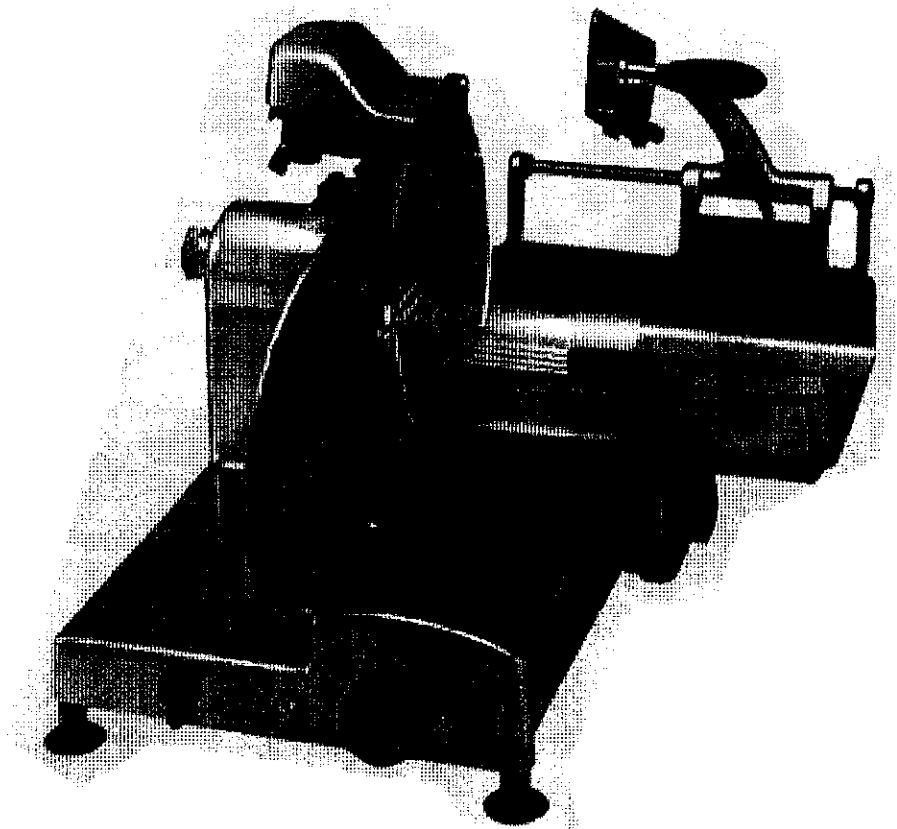

Instruction for User

使用說明書

Technical Information

技術資料

Part 1 Introduction 簡介

Dear Customer,

The OMAS slicing machine and its accessories are manufactured in accordance with the EEC-98/37 Machinery Directive.

They meet all legislative requirements valid at the date of manufacture. Its principle characteristics are easy cleaning, robust manufacture, safe and reliable operation. The materials utilised, anodised aluminium, stainless steel and plastics have been selected with due regard to hygiene regulations and ensure that the machine has a long life.

The regulations applicable to its manufacture are the following:

EN 1974	slicing machines: Safely and hygiene specifications.
EN 60204	Electrical equipment of machines: Part 1 General requirements
89/109/EEC	Directives for the materials and things destined to come into contact with food.
89/336/EEC	Directive on Electromagnetic Compatibility (EMC)
73/23/EEC	Directive on low voltage
The EEC	Declaration of Conformity and the circuit diagram are delivered together with the instruction manual, that we recommend to read with great attention for a correct installation and use of the machine

敬啓者

本產品(奧馬氏切片機)及其配件，全部按照 EEC 98/37 機械的詳細指標生產。並達到所有指標的法定要求。

本產品的基本特性是容易清理，安全和有效的操作。本產品所用的物料是包括鍍鋅鋁合金，不銹鋼和塑料，其中塑料部份是經過詳細的選擇，確保更長的壽命。

應用於本產品的各種規定和指標：

- EN 1974 切片機安全和衛生指標
- EN 60204 電力指標：第一部份，基本要求
- 89/109/EEC 與食物接觸的物料，詳細指標
- 89/336/EEC 電磁的詳細指標
- 73/23/EEC 低電壓的詳細指標

按 EEC 的要求，本產品的使用說明書包括線路圖，建議各用戶詳細閱讀，以便安裝和有效地使用本產品。

Part 2 Contents 內容

Part 1	Introduction	簡介
Part 2	Index	目錄
Part 3.1	General delivery conditions	基本送貨
3.2	Delivery conditions	檢查
3.3	List of components	部件列明
3.4	Machine identification	型號和規格
Part 4.1	Mechanical safety devices	機械安全設備
4.2	Electrical safety devices	電力安全設備
Part 5	Definition	各零件名稱
Part 6	Technical data	技術資料
Part 7.1	Installation	安裝程序
7.2	Electrical supply	電力供應
Part 8.1	Slicer functioning and use	切片機作用
8.2	How to load the product to be cut	如何使用切片機
8.3	How to load short goods to be cut	如何使用切片機， 切小件食物
Part 9.1	Blade sharpening	切片機刀片修磨程序
9.2	Cleaning of the grinding wheels	清潔磨石
Part 10.1	Maintenance	保養程序
10.2	Cleaning	清潔程序
10.3	Components removal	拆卸配件
10.4	Guides lubrication	潤滑程序
Part 11	Problems & corrective actions	問題出現和建議方法
Part 12	Wiring diagrams	線路圖
Part 13	Safety Certificate	安全證明書

Part 3.1 General delivery conditions 基本送貨條件

The machine is always delivered with its packaging. The packaging materials (card-board, polyethylene sacks, expanded polyurethane) are to be considered city waste materials. Even though each material must not be collected separately.

本產品基本上是連原廠包裝一起送貨，包裝用料包括外紙箱和內部保護泡沫。

Part 3.2 Delivery conditions 送貨驗查

Check on delivery that the packaging is unbroken and that the goods correspond to those described on the order or the delivery note; in case of error, inform the shipper immediately.

Remove the slicer from the packaging. The slicer must be placed by two operators on a stable base adequate to support its weight.

本產品收貨時，請驗查包裝是否完整無缺。取出切片機。切片機需要由兩個工作人員提起，並放置在水平位置上，此位置必需有能力承受本切片机的總重量。

Part 3.3 List of components 部件列明

- | | |
|--|-----------------|
| 1. Slicer | 切片機 |
| 2. Accessories (cruet, lubrication oil, brush) | 配件包括塑膠瓶，潤滑油和清潔刷 |
| 3. EC declaration of conformity | CE 證書 |
| 4. Instruction manual | 使用說明書 |
| 5. Wiring diagram | 線路圖 |

Part 3.4 Machine identification 本產品型號和規格

In any communication with OMAS the serial number indicated on the identification label must be quoted.

本產品的型號和規格，均列明於本產品旁邊附設的標籤上。

Part 3.5 Not applicable to this machine 不適用於本型號

Part 4.1 Mechanical safety devices 機械安全設備

The slicer is manufactured according to the EEC 98/37 Machinery Directive.
The mechanical safety devices are the following:

- Protection devices mounted on the product holder to prevent the operator from any accidental contact with the blade.
- Blade guard. This fixed ring protects that part of the blade, which is not used for the cutting operation.
- A special mechanical safety device to sharpen the blade keeping the fingers of the operator away from the cutting edge of the blade.

本產品(奧馬氏切片機)是按照EEC98/37機械的詳細指標生產。

本產品的安全設備包括

- 另加裝的食物盛載盆旁的透明安全罩，可以防止意外地接觸切片刀的刀鋒。
- 切片刀旁邊保護蓋。
- 特別設計的磨刀石裝置，方便和防止使用者接觸切片刀的刀鋒。

Part 4.2 Electrical safety devices 電力安全設備

The electrical safety devices in accordance with the EN60204 standards are the following:

- Start and stop pushbuttons
- Control circuit provided with electric servo-control; in any case of blade clamping the machine must be re-started manually.
- Safety device to stop the rotation of the blade if the clamping handle of the blade guard is released.

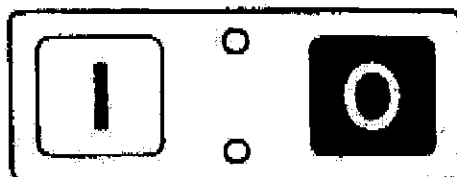

本產品的電力安全設備是按照 EN 60204的指標，其中包括：

- 總開關掣的裝置
- 電力輔助裝置
- 停止轉動切片刀的裝置

注意

當本產品停止使用時，請確保關閉總開關掣和厚薄調節器調節至零 "0" 位置。

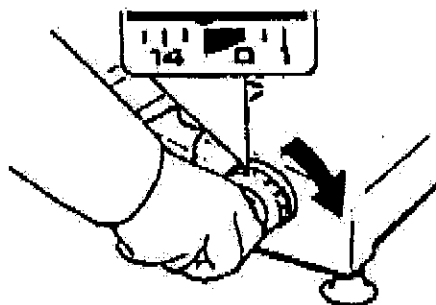

Part 5 Definitions 各部件名稱

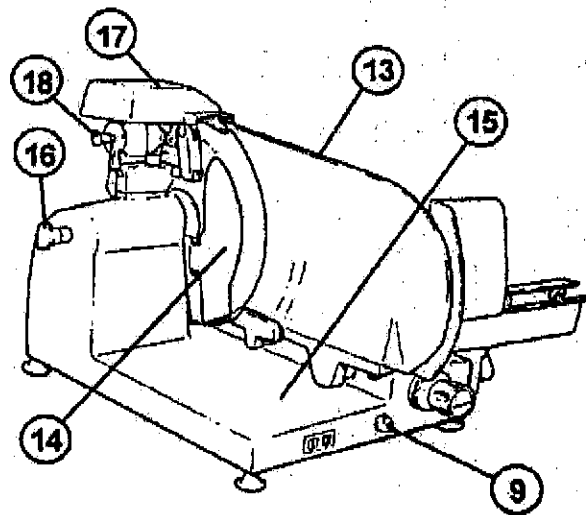
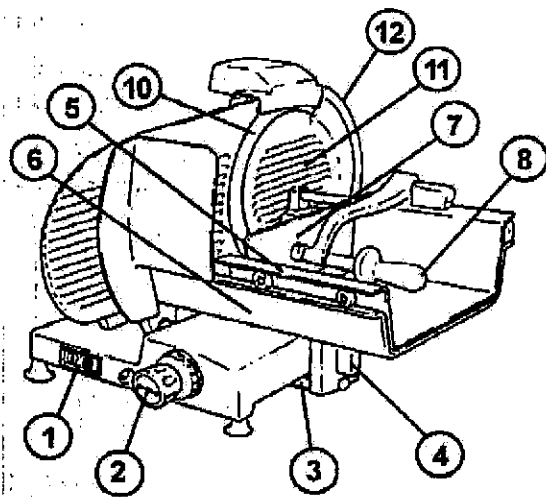

- | | |
|---------------------------------------|--------------|
| 1. Control pushbuttons | 總開關掣 |
| 2. Slice thickness control | 厚薄調節器 |
| 3. Carriage | 滾軸的路軌 |
| 4. Product holder clamping handle | 食物盛載盆，鎖定旋鈕 |
| 5. Feed carriage | 滾軸路軌食物盤 |
| 6. Product holder | 食物盛載盆 |
| 7. Last slice device | 食物盛載盆上固定食物手柄 |
| 8. Pusher | 推手柄 |
| 9. Carriage bar oiler | 滾軸路軌注(潤滑)油孔 |
| 10. Blade | 切片機刀片 |
| 11. Blade cover | 切片機刀片保護蓋 |
| 12. Blade guard | 切片機旁邊保護蓋 |
| 13. Slice thickness plate | 切片機旁邊的支撐板 |
| 14. Slice deflector | 切片機刀片的支撐板 |
| 15. Slice receiving tray | 切片機刀片盛載處 |
| 16. Blade cover fastener handle | 切片刀保護蓋鎖定旋鈕 |
| 17. Blade sharpener cover | 切片機磨刀石保護蓋 |
| 18. Integrated blade sharpener device | 切片機磨刀石裝置 |

Part 6 Technical data 技術資料

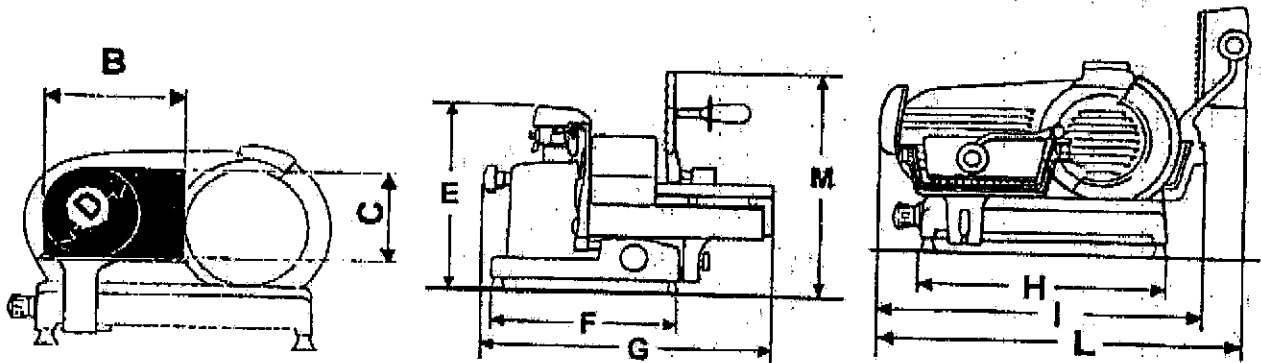

- | | |
|---|---|
| 1. Blade mm | 切片機切片刀直徑 : 300mm |
| 2. Slicing capacity mm | 切分機可供切片尺寸 : B: 280mm
C: 230mm
D: 230mm |
| 3. Dimension mm | 外形尺寸 : E: 490mm
F: 380mm
G: 640mm
H: 500mm
I: 720mm
L: 810mm
M: 620mm |
| 4. Weight kg | 重量 : 淨重 36 公斤 (kg)
毛重 45 公斤 (kg) 連包裝 |
| 5. Range temperature | 使用溫度範圍 : +5°C / +40°C |
| 6. Slice thickness control mm | 切片機可調節厚薄 : 0mm - 14mm |
| 7. Blade rev /min | 切片刀轉動轉數 : 每分鐘 200 轉 (rev / min) |
| 8. Acoustic dB | 噪音值 : 低於 70 db |
| 9. Protection grade of the electrical system and switches | 電力系統和開關掣的保護值 : IP65 |

Part 7.1 Installation 安裝程序

The slicer must be mounted horizontally on a stable, robust and antiskid base adequate to support its weight (Part 6). The suggested height of the working table is of about 800 mm. It must be checked that the product holder is not clamped and the product to be cut can be easily loaded.

Before connecting the plug clean off the protective oil from the machine.

本產品必需放置於一水平工作台，和有能力承受本產品總重量的地方。

建議工作檯高度為 800mm

在未使用之前，請把切片機上的保護油抹去。

Part 7.2 Electrical supply 電力供應

The machine must be installed in the proximity of a mains socket.

Check that the power supply voltage corresponds to that described on the information label and that it is connected to an adequate earth.

本產品必需安放於電源供應附近。並檢查電源供應是否與本產品電源要求，互相符合，並接有地線，以策安全。

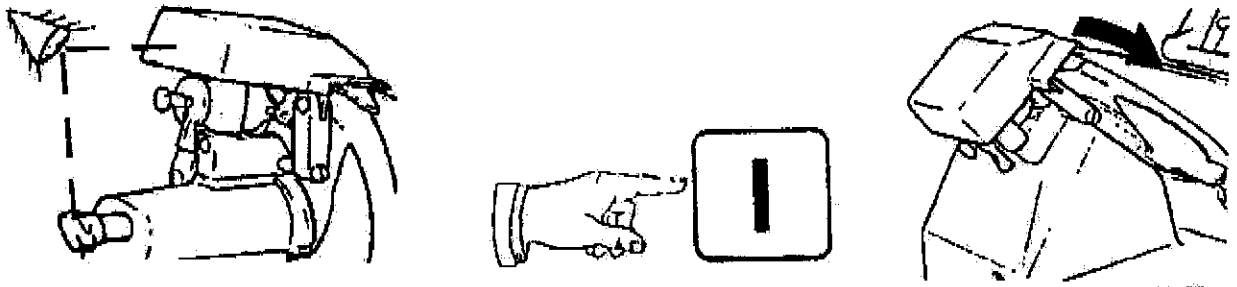

1. Connect the plug
將電源插上。
2. Check that the blade cover fastener handle is tight screwed
檢查切片刀保護蓋鎖定旋鈕是否鎖定和固定。
3. Check that the blade sharpener is lowered and the protective cover is closed
檢查磨刀石裝置是否放回原位和磨刀石保護蓋是否蓋著。
4. Press pushbutton (I) to switch on the machine.
按下(I)開關掣開放。
5. The blade must rotate in the direction indicated by the arrow.
切片刀即時轉動，按圖上轉動方向。

Part 8.1 Slicer functioning and use 切片機作用

The machine is particularly suitable for fresh foodstuffs.
本產品特別適用於新鮮食物。

注意

The following cannot be sliced: not eatable products, foodstuffs with bones, frozen products.
本產品不可以使用下列食物：不可以食用物品：含骨食物，冰凍食品。

Part 8.2 How to load the product to be cut 如何使用切片機

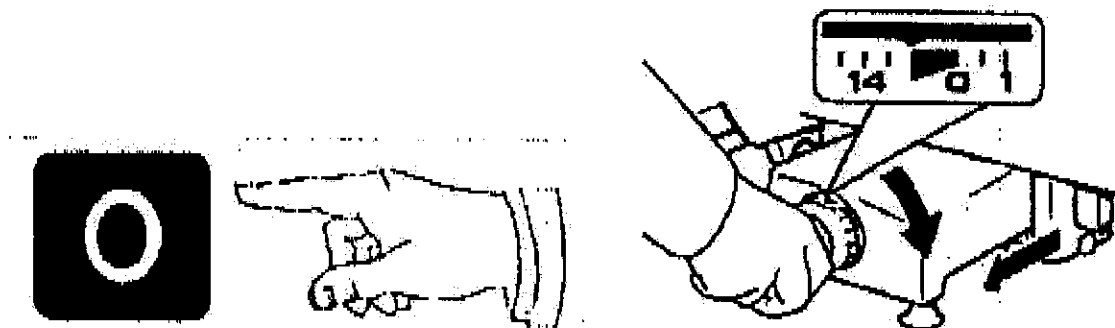

1. Check that the slicer is off and position the slice thickness control to zero.
檢查切片機是否開關和確保厚薄調節器調校至零 "0" 位置。
2. Push the product holder towards the operator
拉回食物盛載盆至左邊開關位置。

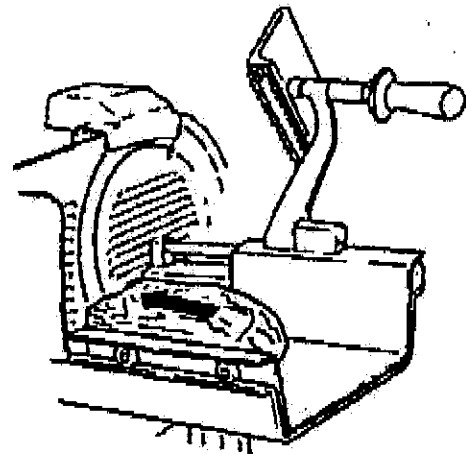
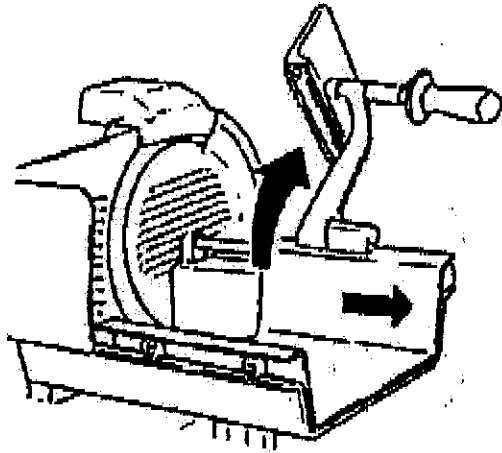

- Remove the feed carriage from the slice thickness plate. Lift the last slice device at the end of the stroke

提起手柄，拉開食物盆，放入食物，並以手柄固定食物。

- Place the product to be cut against the wall of the pusher towards the slice thickness plate

把需要切片的食物放入盛載盆內。

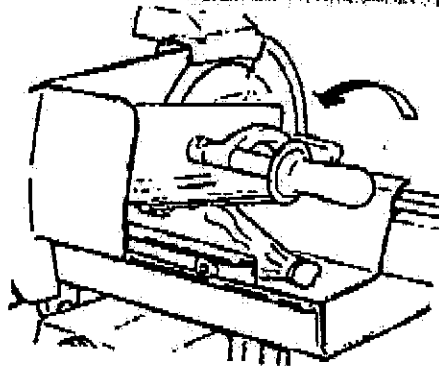

- Rotate and push the last slice device on the product to be cut.

轉動切片裝置，將需要食物切片。

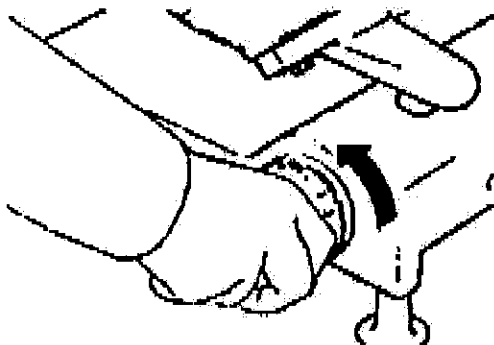

- Rotate the slice thickness control to the thickness desired

轉動並調節厚薄調節器至適當位置。

- Press switch (I) to switch on the machine

按下開關掣開啓。

- At constant speed feed the product holder to the blade stroke end then return to the operator and repeat the operation.

利用適當的速度，推動食物盛載盆至末端後，拉回原來位置，重覆進行。

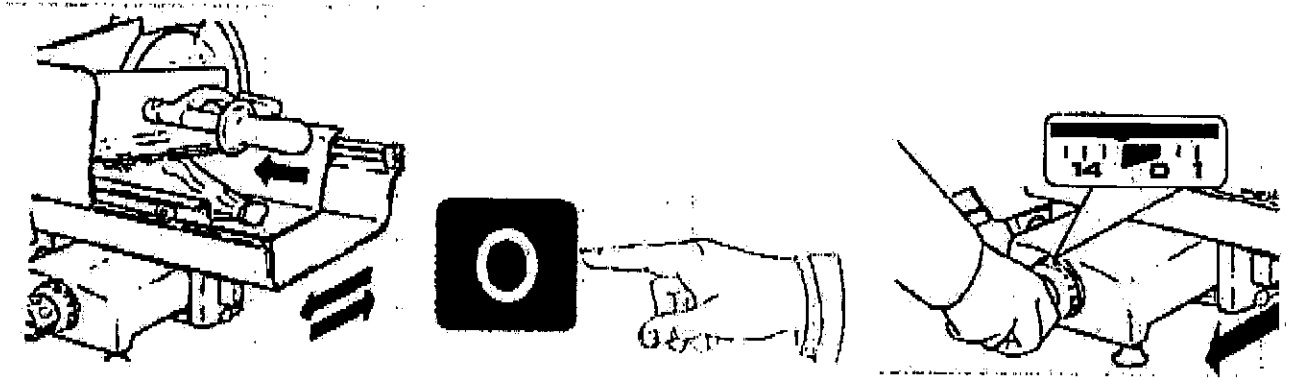

After cutting the goods, re-position the product holder towards the operator. The rotation of the blade stops by pressing pushbutton (O). Re-position the slice thickness control to zero, and unload the product.

當食物切片完畢後，拉回食物盛載盆至原來位置，按下開關掣，關閉切片機，轉動厚薄調節器至零"0"位置。

Part 9.1 Sharpening Operation 切片機刀片修磨程序

Wear protective gloves. For a correct sharpening of the blade follow these instructions
首先帶上保護手套和按以下程序工作:-

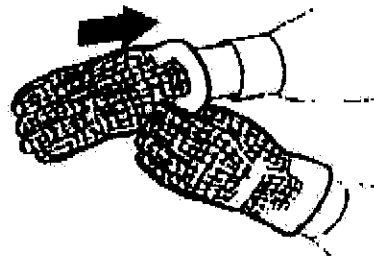

1. Clean the blade removing any greasy residue (Part 10)
除去刀片上的污積或油積

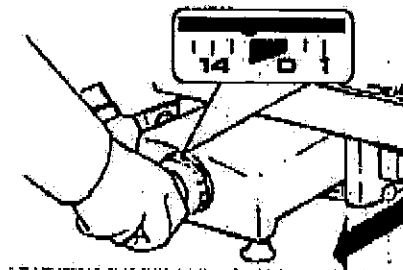
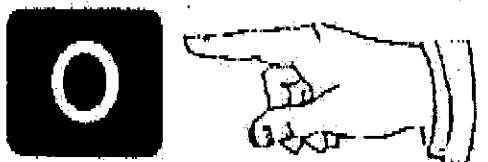

2. Make sure that the machine is off
確保切片機關上電源
3. Rotate the slice thickness control to zero to make sure that the blade is covered by the slice thickness plate.
轉動厚薄調節器至"0"位置

注意

During the following operations the blade must always be covered by the removable protection.
進行以下程序，請小心刀片和各保護裝置。

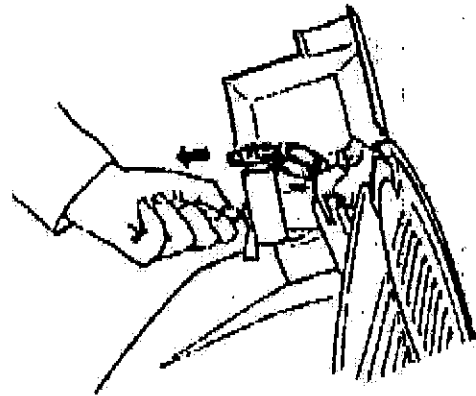
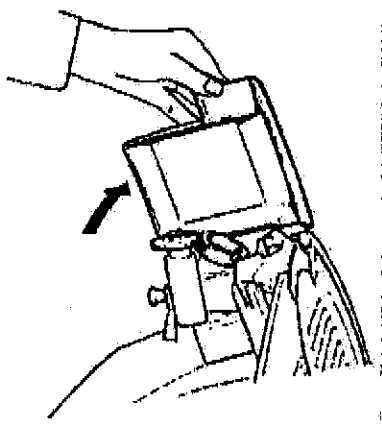

4. Lift the sharpener cover
揭起磨刀石保護蓋
5. Pull the sharpener release handle
拉起磨刀石裝置
6. Rotate the device to the blade
向上轉動磨刀石裝置至刀片位置

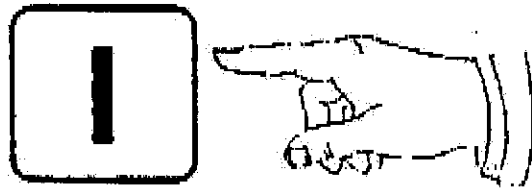
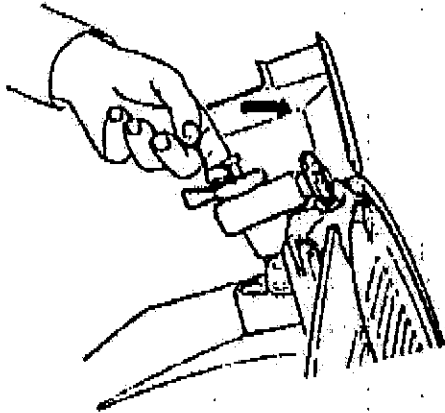

7. The blade sharpener will be correctly fixed
磨刀石裝置會自動定位
8. Push pushbutton (I) to start the machine
按下開關掣開啓

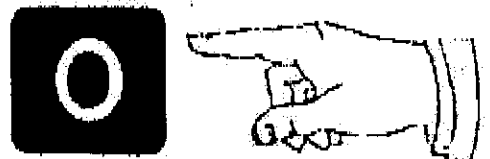
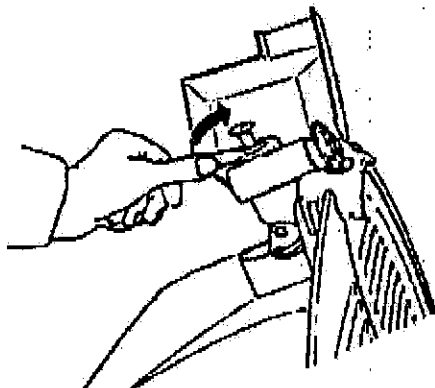

9. Sharpening : rotate the lever and bring the two grinding wheels near the blade. The blade are
Simultaneously sharpened and burred.
磨刀過程：轉動水平桿，令兩面磨刀石接觸刀片兩側。磨刀過程只需 10-15 秒。
10. After sharpening press the stop "O" pushbutton
磨刀程序完畢後，按下開關掣，關閉切片機

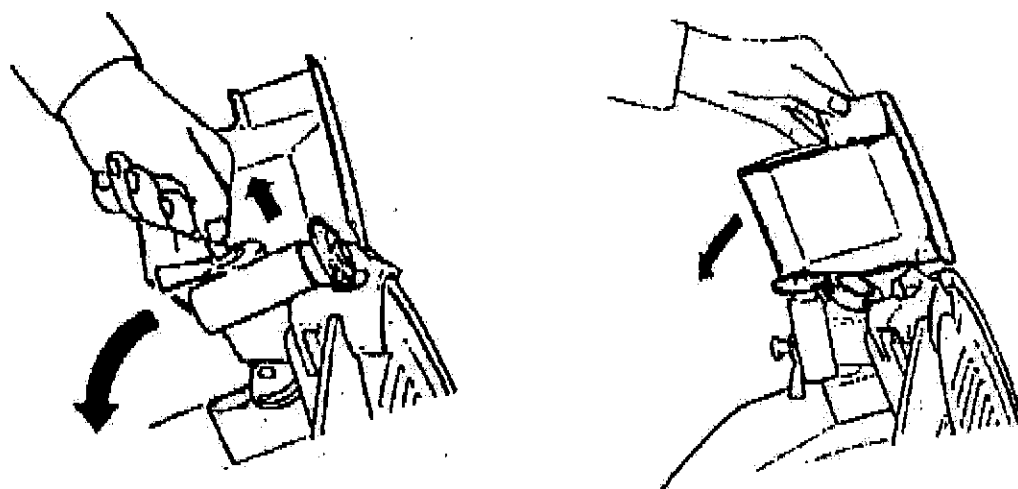

11. Pull the handle to reposition the sharpener to the initial position

拉起並向後轉動磨刀石裝置，放回原位

12. Lower the sharpener cover

放回並蓋好磨刀石保護蓋

Part 9.2 Cleaning of the grinding wheels 清潔磨石

The grinding wheel and its pin can easily be removed from the sharpener taking it off in the direction of the arrow. For an adequate sharpening the grinding wheel must always be clean. Remove dirt and grease with alcohol and the special brush supplied.

磨刀石安裝軸，可以容易地拔出(如圖，並按箭咀方向拔出)請經常清理磨石上的油積和污積，確保正常使用。

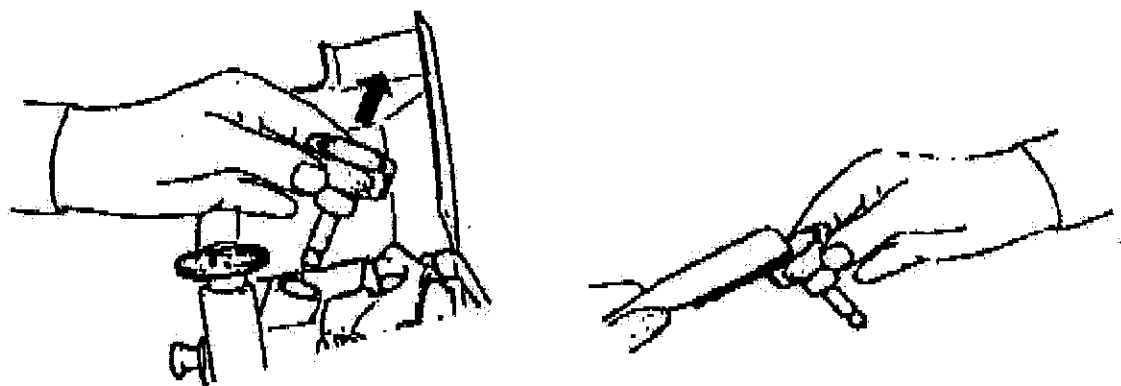

Part 10.1 Maintenance 保養程序

All cleaning and maintenance operations must only be carried out with the machine disconnected and isolated from the mains supply and the slice thickness control on zero. All cleaning and maintenance operations must be carried out whilst wearing protective gloves.

所有清潔和保養程序進行前，必需關閉電源和調校厚薄調節器至"0"位置，並帶上保護手套，確保安全。



Check of the electric cable – It is recommended to check the wear of the electric cable at regular intervals.

檢查電源線 - 經常檢查電源線保護外層，有否損傷。

Part 10.2 Cleaning 清潔程序

The machine must be cleaned once a day or more frequently if necessary. Clean all the parts using a cloth sprinkled with water and washing up liquid (do not use strong detergents) and a brush.

本產品使用後，必需最少每一日清潔一次或以上。清潔時，利用海棉，軟布和清潔劑清洗。

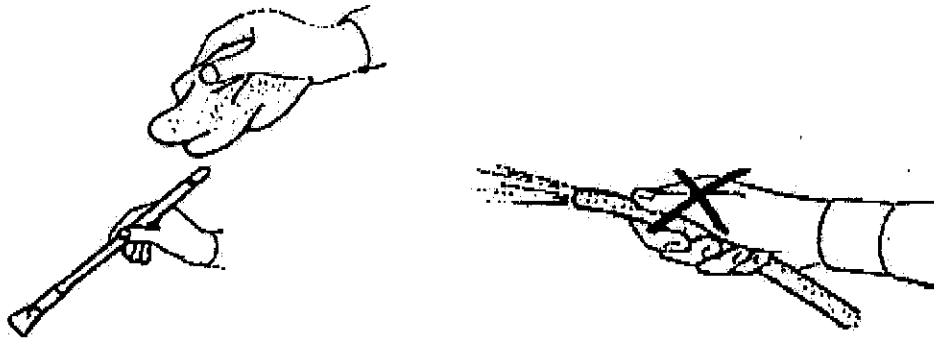

注意

Do not use water jet

清潔時，切勿用清水沖洗。

Part 10.3 Components removal 拆卸配件

1. Position to zero the slice thickness control.
轉動厚薄調節器至 "0" 位置
2. Loose the product holder clamping handle by rotating it in a counterclockwise direction.
反方向轉動食物盛載盆以固定鎖定旋鈕

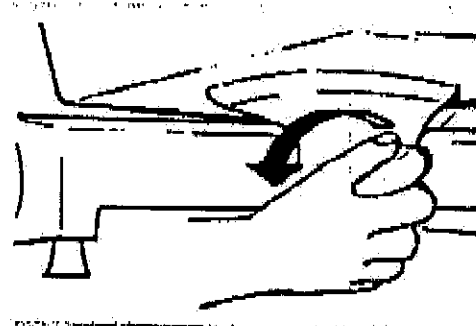
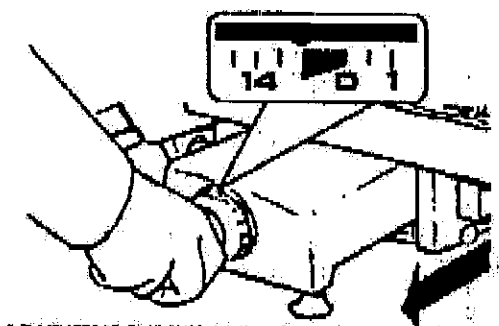

3. Push the product holder towards the operator until it clicks. The click will inform the operator that the product holder is clamped.
推動和鬆脫食物盛載盆
4. Lift the product holder by slipping it out from its support
揪出 / 拉起食物盛載盆(如圖)

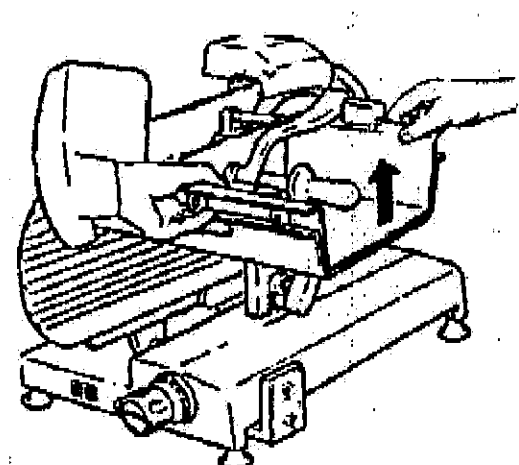
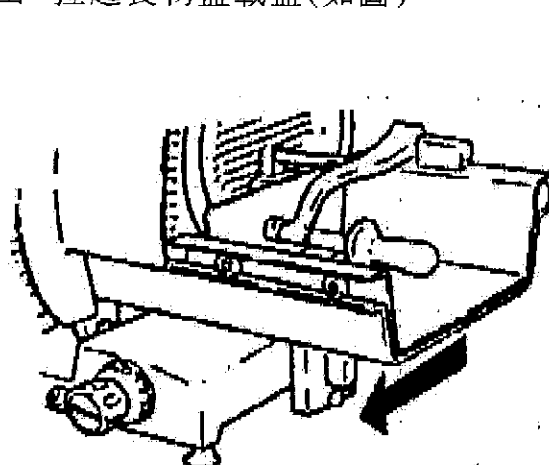

5. Rotate the slice deflector and keep it away from the blade.
轉動切片機背面的切片刀支撐板(如圖)

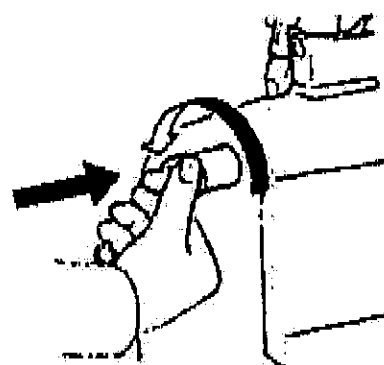
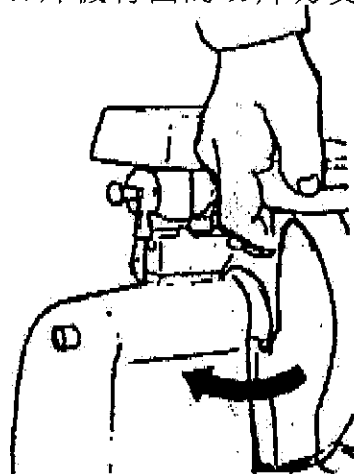

6. Loosen the blade cover fastener handle by rotating it in a counterclockwise direction.
反方向轉動切片機保護蓋鎖定旋鈕
7. Push on the handle in the direction indicated by the arrow to lift the blade cover from the blade.
將保護蓋鎖定旋鈕向上推

8. Lift the blade cover.
揭起刀片保護蓋

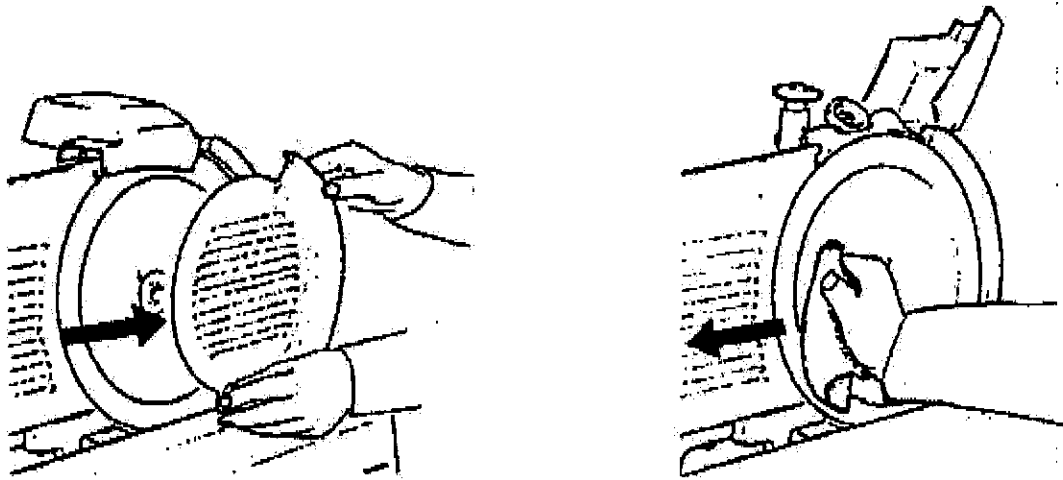

9. Press a damp cloth on the front side of the blade and move slowly from the center towards the edge in the direction of the arrow.
利用濕布清潔刀片前端
10. Follow these instructions to clean the back side of the blade.
同樣地，清潔刀片背面

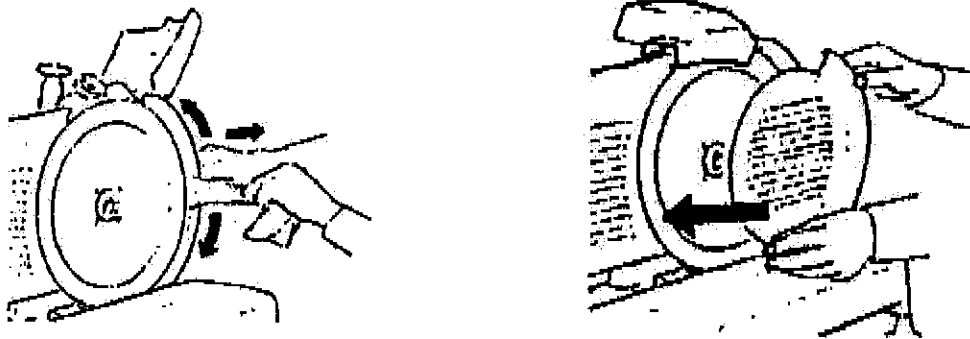

11. With a cloth dry both sides of the blade following this procedure.
利用乾布清潔和抹乾刀片兩邊
12. Insert a damp cloth between the blade and the protection ring. Pull it outwards and rotate it to clean the internal side of the protection ring
將濕布放入刀片旁邊的保護環內，上下方向移動，並清潔其中

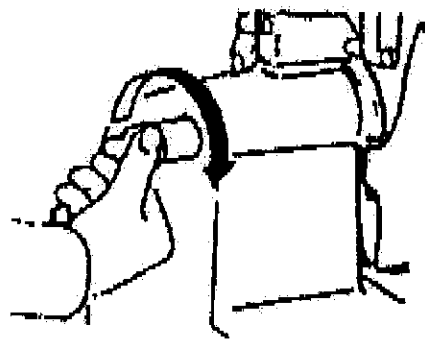

13. After cleaning re-position the blade cover, insert the fastener and screw in a clockwise direction to clamp the blade cover. Lower the sharpener protective cover.
清潔後，放回刀片保護蓋，放入鎖定旋鈕，並固定保護蓋。相反地把其他拆卸的配件重新裝回。

Part 10.4

Guides lubrication

潤滑程序

This operation must be performed after cleaning the slicer or whenever the sliding is difficult.

此程序必需在每次清潔後進行或滾軸路軌使用困難時進行。請利用隨機附送的潤滑油。

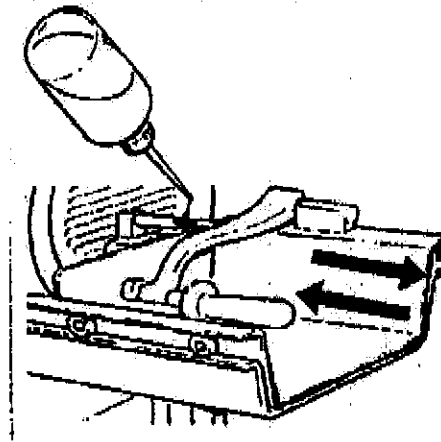

1. Lubrication of the guide bar of the product holder: 潤滑食物盛載器手柄
- 1.1 Drop some oil on the bar
把潤滑油滴在手柄支持軸上。
- 1.2 Let the last slice device slide on the guide bar
利用手柄嘗試推動，並將之潤滑。

2. Lubrication of the guide bar of the product holde carriage 潤滑食物盛載盆滾軸

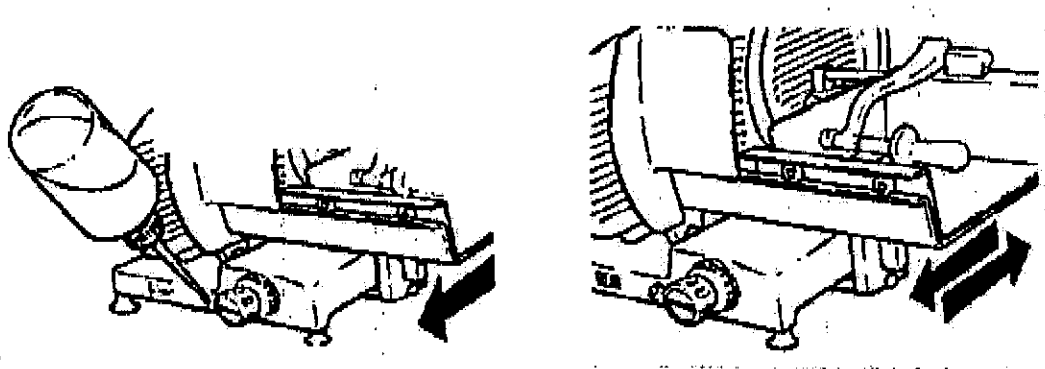

- 2.1 Push the product holder towards the operator
將食物盛載盆向左方拉出。
- 2.2 Pour the lubricating oil into the special carriage bar lubricator
將潤滑油從滾軸路軌注油孔注入。
- 2.3 Push the product holder to and fro and repeat the operation. Re-position it towards the operator.
左右推動食物盛載盆，並將滾軸潤滑。

Part 11 Problem 問題出現

Problem 1 問題 1	The machine vibrates, overheats and emits a foul smell. 本產品非常振動和產生熱量和氣味。
Corrective action	Stop it immediately and check that the voltage corresponds to that described On the label
建議方法	立即停止操作和檢查供電是否與本產品標籤相乎 (見圖 7.1)
Problem 2 問題 2	The blade cannot be sharpened any longer. The sharpening is no regular. 刀片不能修磨，修磨程序不正常
Corrective action	Clean the grinding wheels of the sharpener and check the wear of the blade (Part 9).
建議方法	清潔磨刀石和檢查刀片有否缺口 (見圖 9.1)
Problem 3 問題 3	ON pushing the start pushbutton the machine does not start. 按下開關掣，開啓切片機，切片機不工作
Corrective action	Check the safety devices (Part 7.1)
建議方法	檢查各安全設備 (見圖 7)

本中文譯本如與英文有異，一概以英文為準。

Part 12 Wire Diagram 線路圖

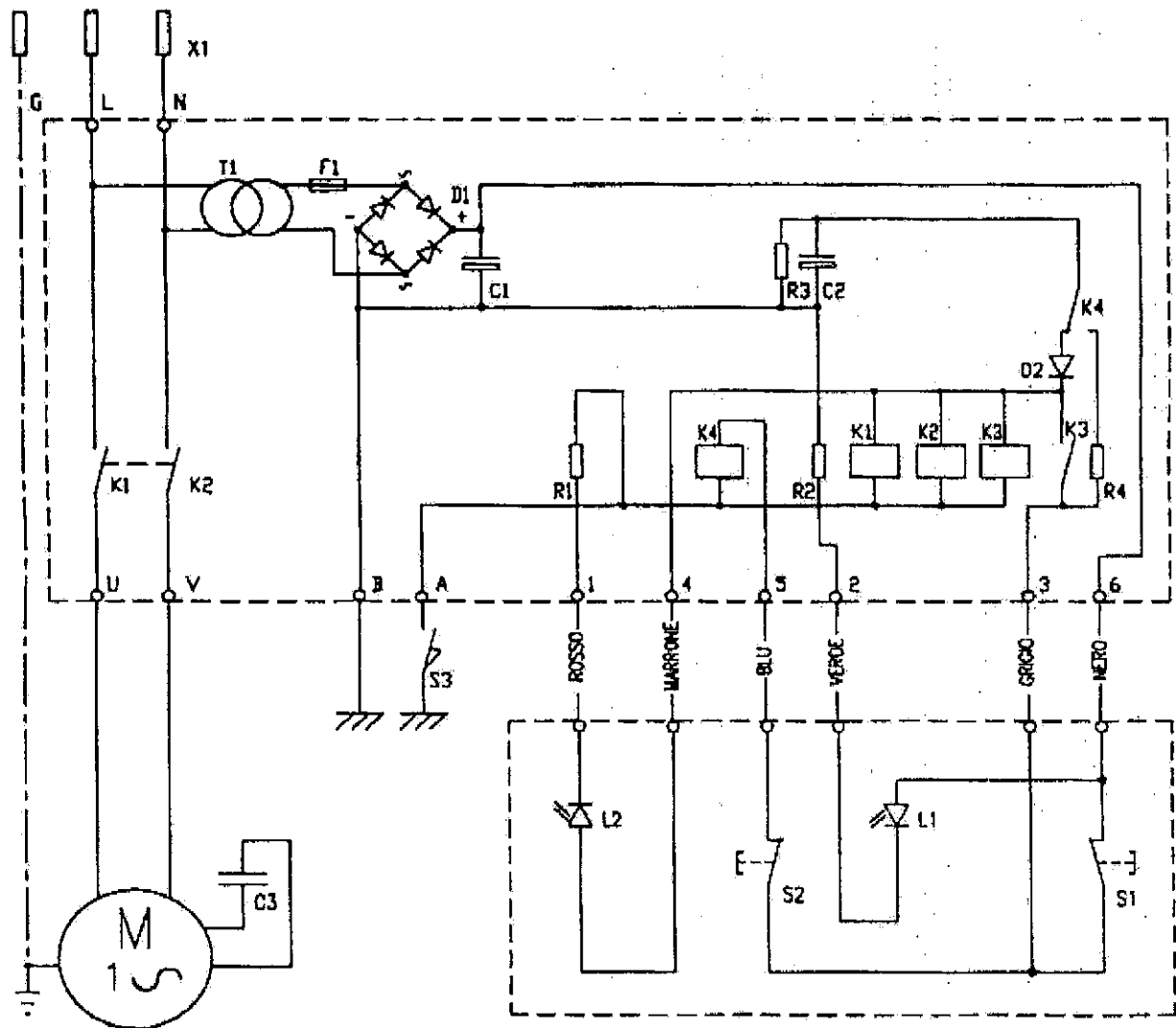

POS	DESCRIZIONE	POS	DESCRIZIONE
X1	SPINA	C3	CONDENSATORE 5 uF VS25E-522-822-842
T1	TRASFORMATORE 0-230/0-24V 2,2VA	C3	CONDENSATORE 8 uF GL25E-30E H-L-M25-30E
F1	FUSIBILE 160mA	R1/R2	RESISTENZA 2k2 1/4W
D1	RAADDRIZZATORE 1A	R3	RESISTENZA 10k
D2	DIODO DI PROTEZIONE G001	R4	RESISTENZA 47 Ohm
L1	LED LINEA ARANCIONE	K1/K2	RELE' DI COMANDO 12Vcc OMRON
L2	LED MARCIA VERDE	K3/K4	RELE' DI COMANDO
C1	CONDENSATORE ELETTROLITICO 220uF 50 V	S1	PULSANTE STOP
C2	CONDENSATORE ELETTROLITICO 220uF 50 V	S2	PULSANTE START
		S3	PROTEZIONE DISCO COPRILAMA
N° DISEGNO	DATA	MACCHINA	 Food machinery Via 4 Novembre, 6 - 21040 Oggiono S.Stefano (Varese) Telefono (0331) 214.311 - Fax (0331) 214.350
S 2244	26 - 03 - 99	522-822-842 VS-GL H-L-M (25E-30E)	
TENSIONE: 230V-50Hz			
Ci riserviamo la proprietà a termini di legge di questo disegno con divieto di riprodurlo anche in parte o di renderlo noto a terzi.			

Part 13 Safety Certificate 安全証明書

AFFETTATRICI
TRITACARNE
SEGAOSSII
INTENERITRICI

OMAS
Food machinery

EC Declaration of Conformity
Dichiarazione CE di Conformità

SLICER
AFFETTATRICE

OMAS Mod. **H 30E**
Mod.

Ser. Nr
Matr.

The machine is in conformity with following standards:

- 98/37/CEE Machinery directive
- EN 1874 Food processing machinery
- Slicing machines
- Safety and hygiene requirements
- EN 60204 Electrical equipment of industrial machine
Part 1 - General Design
- 89/109/CEE Directive for the materials and things
destined to come into contact with food
- 89/336/CEE Directive on Electromagnetic Compatibility
(EMC)
- 73/23/EEC Directive on low voltage

La macchina e' conforme alle seguenti norme:

- 98/37/CEE Direttiva Macchine
- Macchine per la lavorazione degli alimenti
- Affettatrici
- Requisiti di igiene e sicurezza
- Equipaggiamento elettrico delle macchine
industriali: Parte 1- Progettazione generale
- 89/109/CEE Direttiva per i materiali
e gli oggetti destinati a venire a contatto
con i prodotti alimentari.
- 89/336/CEE Direttiva sulla Compatibilità
Elettromagnetica (EMC)
- 73/23/CEE Direttiva bassa tensione

Managing Director

OMAS S.p.A.

Amministratore delegato

Walter Rabolli



Oggiona S. Stefano, 31/05/00

OMAS S.p.A.
Via 4 Novembre, 6
21040 Oggiona S. Stefano
(Varese) - Italy

Tel. ++ 39 - 0331 214311
Fax ++ 39 - 0331 214350
E-mail: omas@omaspa.it
Internet: www.omaspa.it

Cap. Soc. L. 800.000.000 i. v.
Reg. Imp. Varese n. 7933
R.E.A. n. 50608 Va - Export VA013113
C. F. e P. IVA IT 00217450121